

SCA-M30

Ceiling Microphone

SONY
make.believe

- All-in-one Type of Ceiling Microphone
- Specially Designed for Video Security
- Hi-Fi Sound Quality



KEY FEATURES

All-in-one microphone that requires no external amplifier or external power supply

- Built-in amplifier with the line-level output capability
- Plug-in power supply from Sony SNC video security cameras.

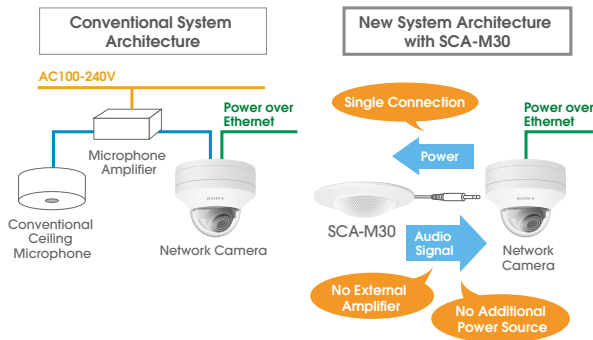

Two methods of mounting

- **In-ceiling Mount:** For use on ceilings where a hole for attachment* is available, the main microphone main unit can be inserted directly onto the ceiling and fixed instantly using the mounting springs.
- **Ceiling Surface Mount:** For used on ceilings without a hole, the SCA-M30 can be installed with a supplied mounting bracket.

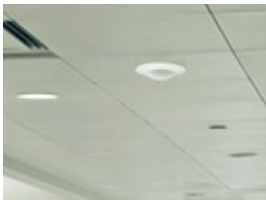
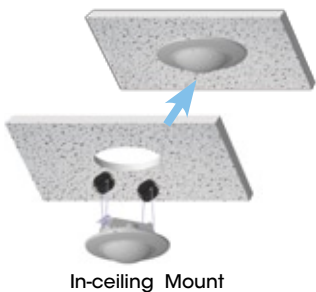

* 90 mm to 100 mm (3 5/8 inches to 4 inches) in diameter

Superb Sound Quality

High sensitivity

- Supersensitive unidirectional electret condenser transducer picks up clear sounds from the front, while acoustic shielding construction suppresses noise from the sides and back.
- Pickup direction can be targeted very simply by rotating the grill section.

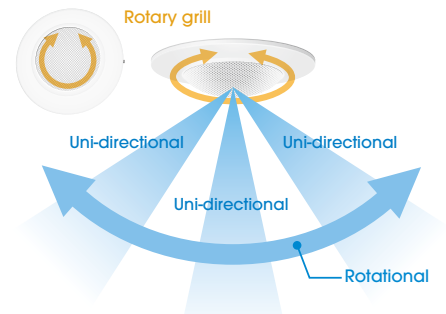

- Selectable gain to match the requirements of different connected devices.
- Boundary effect architecture to collect more sounds.

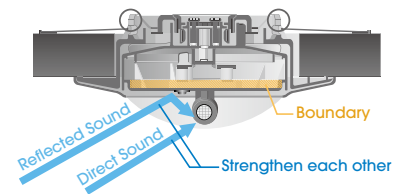

Low Noise

- Sealed ceiling architecture eliminates noise above the ceiling.
- Rubber-cushioned element mount suppresses pickup of vibration noise.
- Folding mounting springs with rubber bushing suppress pickup of direct external vibrations.
- Low-cut filter achieves clear voice capture.

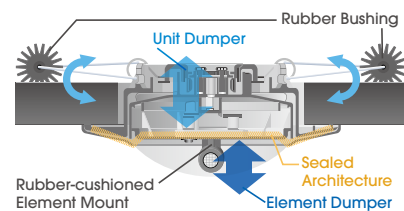

SYSTEM CONFIGURATION

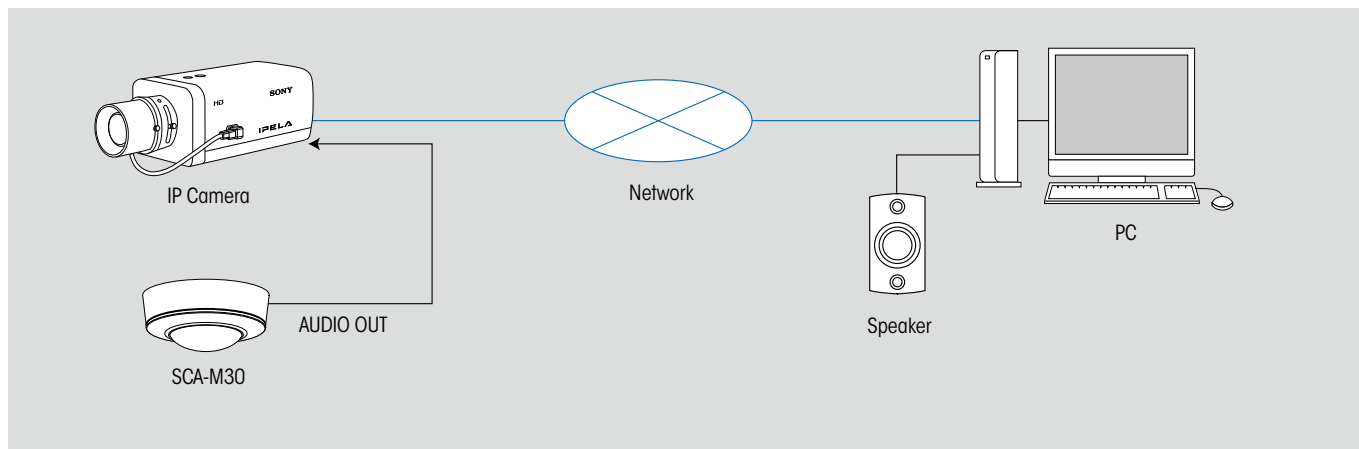

SPECIFICATIONS

SCA-M30	
Capsule type	Electret condenser
Directivity	Uni-directional with Direction Rotation mechanism
Frequency response	300 Hz to 10kHz
Sensitivity	-35dB*1 ±3.5dB (at 1 kHz)
Signal-to-noise ratio	60dB and more (IEC179 A weighted, 1KHz, 1Pa)
Sound enhancement technology	Rubber cushioned element mount Folding mounting springs with rubber bushing Sealed ceiling architecture Boundary effect architecture Low cut filter
Power supply	Plug in Power DC 1.5 V - 9 V
Current consumption	0.5mA and less
Output connector	ø 3.5mm mini-plug (3poles) x Tip-Ring short connected
Connector cable length	Approx.300 cm (118 1/8 inches)
Signal output level	10mVrms ATT 0dB, 6dB, 12dB selectable
Installation	Ceiling Surface, Flush in Ceiling
Dimensions	132 x 60 mm (5 1/4 x 2 3/8 inches) (with bracket) 126 x 55 mm (5 x 2 1/4 inches) (without bracket)
Mass	146g (5 oz) 225g (8 oz) with bracket (Not included cable)
Operating temperature	0 °C to +50 °C (32°F to 122°F)
Storage temperature	-20 °C to +60 °C (-4°F to +140°F)
Finish	Mat white color
Supplied accessories	Bracket(1), +BV 4 x 20(2), +K 2.6 x 20(3) Operating instruction(1), Warranty booklet(1)

*1 0 dB=1 V/Pa, at 1kHz

DIMENSIONS

Unit: mm (inches)

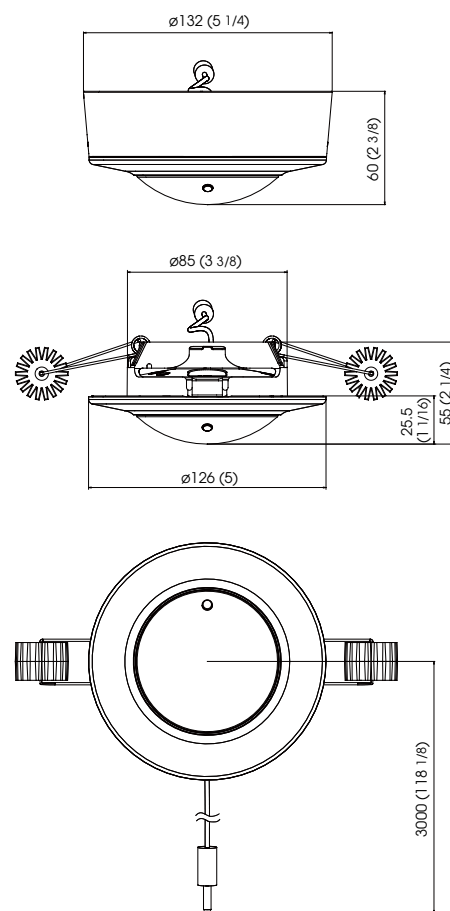

Distributed by

© 2010 Sony Corporation. All rights reserved.
 Reproduction in whole or in part without written permission is prohibited.
 Features and specifications are subject to change without notice.
 Sony is a registered trademark of Sony Corporation.
 All other trademarks are the property of their respective owners.